

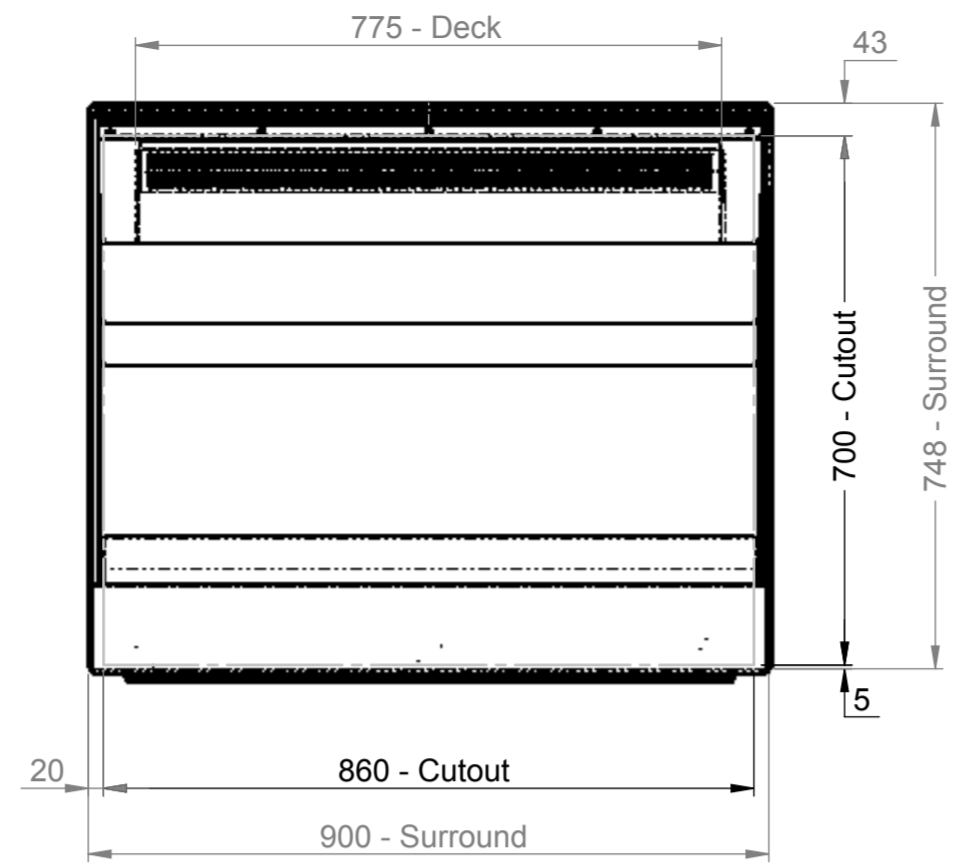

This drawing and the information properties contained there on is the property of Counterline Ltd and must not be copied or issued to a third party without the prior consent of Counterline Ltd.

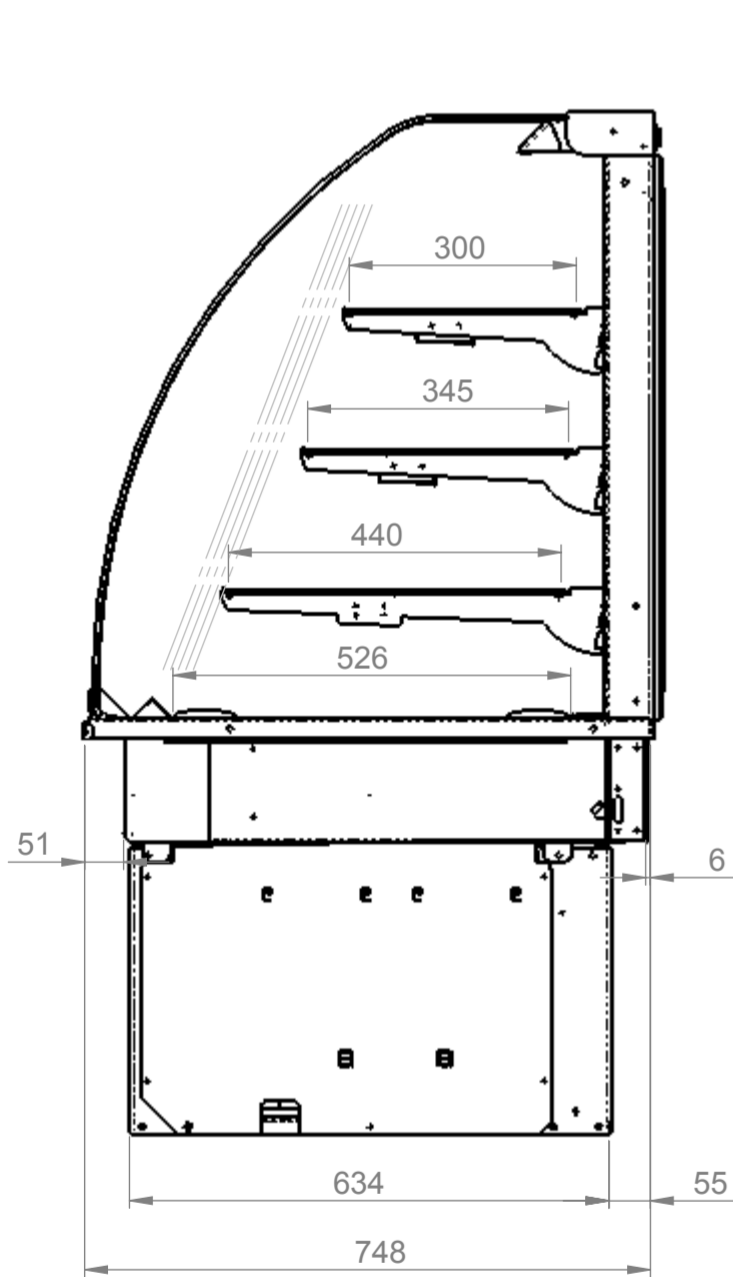

Plan



End elevation

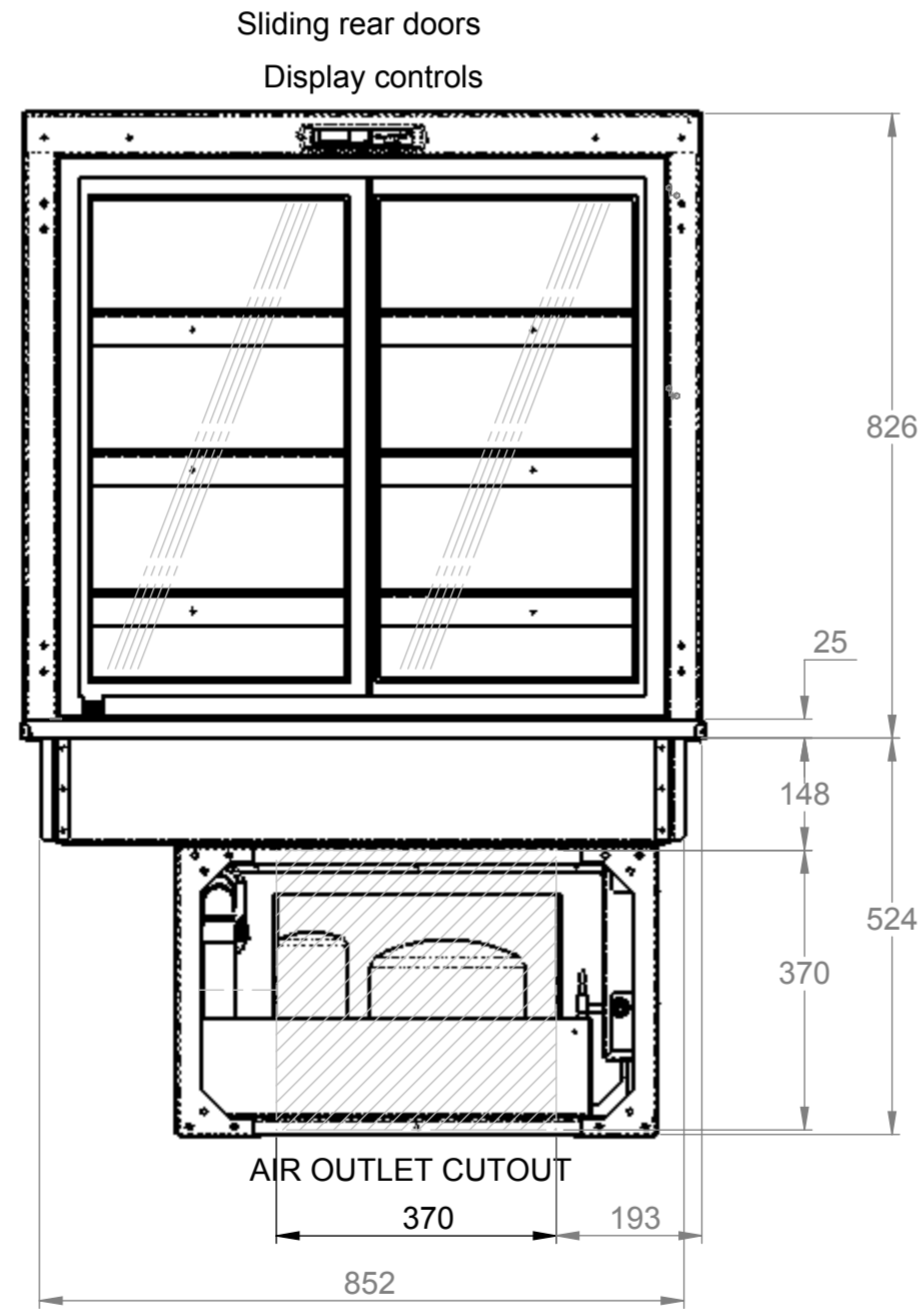

Rear elevation

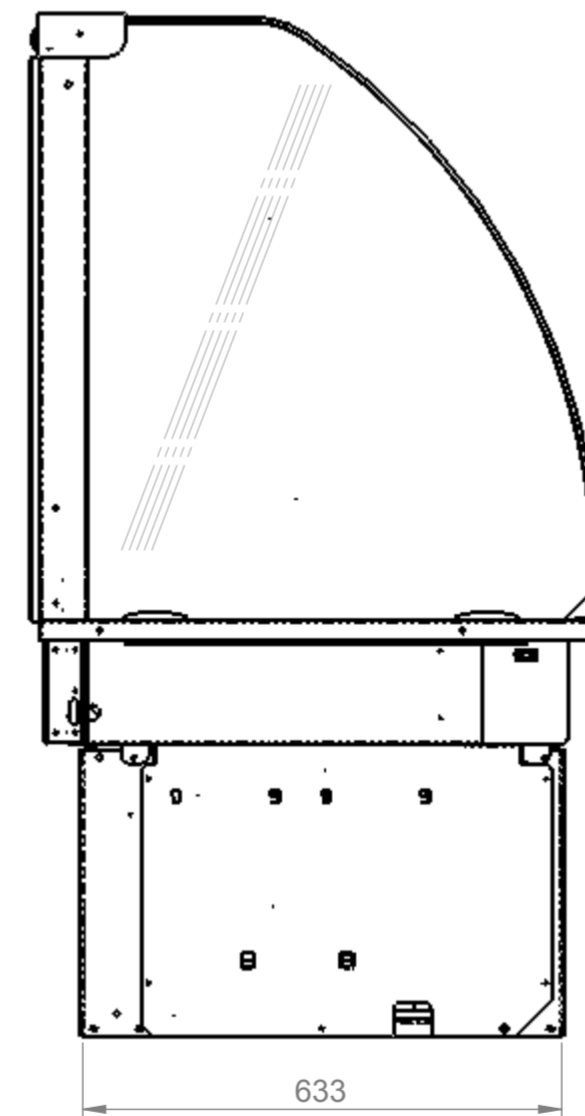

End elevation

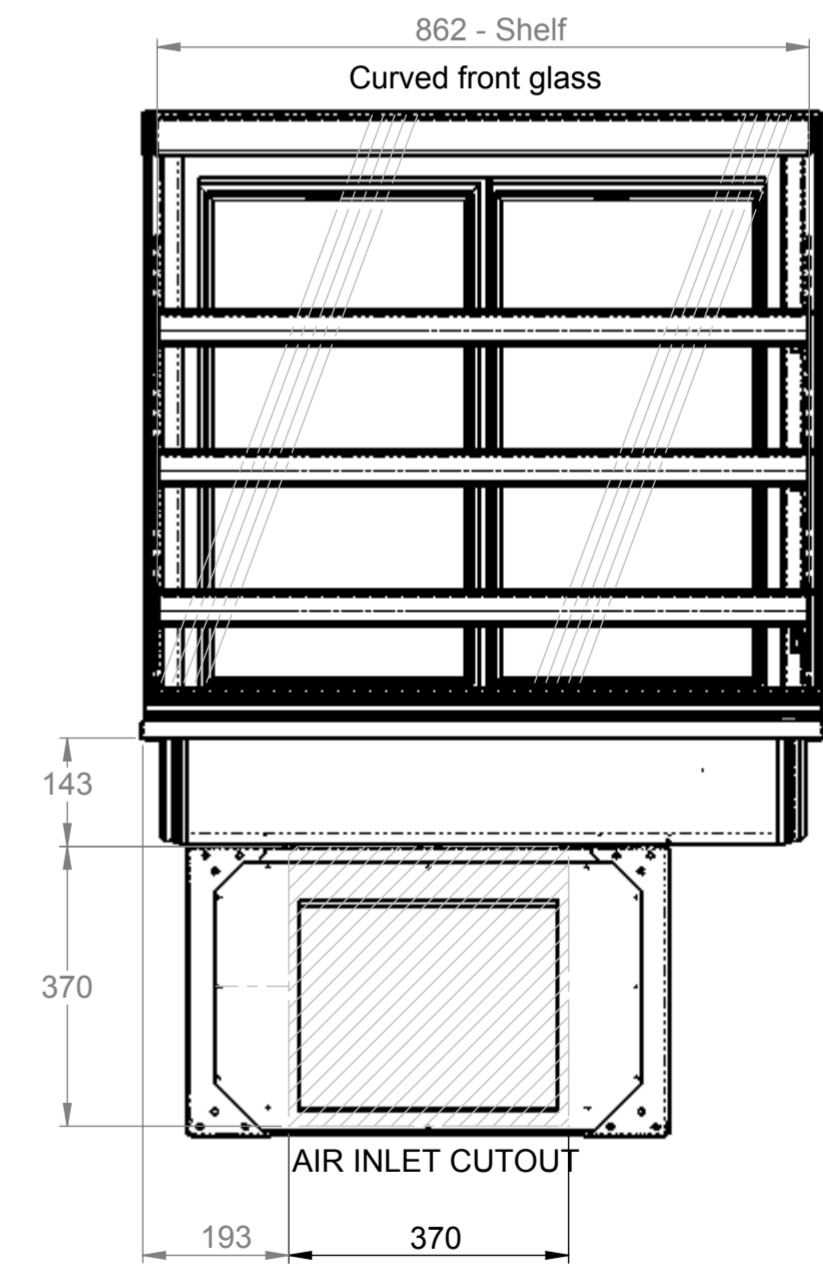

Front elevation

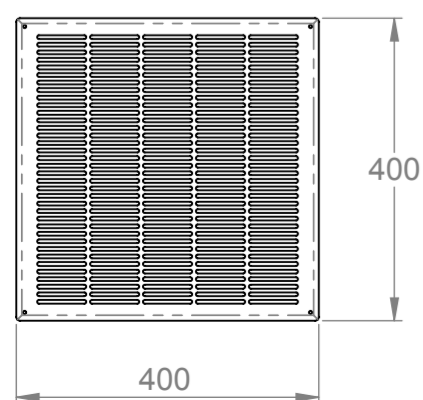

Stainless steel air inlet-outlet grille details

Electrical Spec - 13A, 230V, 1.9Kw
via 13A plug top on 2.5 Metre lead
Weight - 163Kg Approx

Assembly No - VCDI900-GO

Issue	Date	Description
Randles Rd, Knowsley Business Park, Merseyside L34 9HZ. Tel: 0151 548 2211 Fax: 0151 549 2179		
Title: Vision Enclosed Chilled Display 900		
Drng No :	Issue:	Date: 20/03/2015
14-241--A		Scale: 1:10 @ A2
		Chk'd:
Drn by: G Burgess	All dims in MM	Date: